

Urethane Storage Block Set

SINGLE BOLT FASTENING TYPE



Urethane Storage Block Set (①, ②, ③, ④)

USPHA (Retainer used for SORTA)
USPHB (Retainer used for SORTB)



*Retainers are fixed to urethane.

See page 1233 for storage methods.

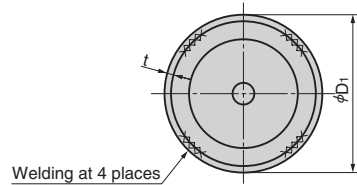

Load F(k N)

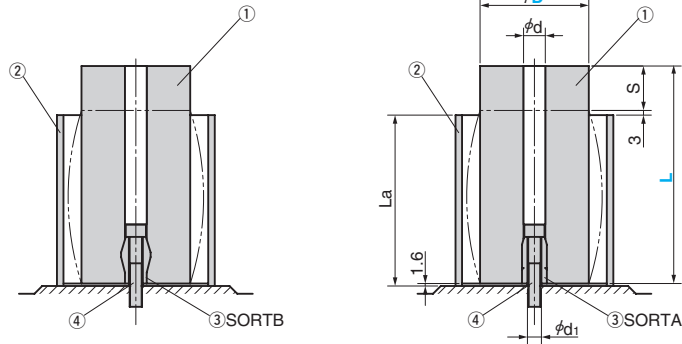

Urethane Storage Pipe (②)

USPH

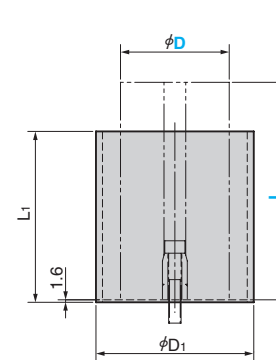

Material: SGP (Bottom plate: SPC)

Urethane Spring (①)

USA

(with SORTA ①, ③ USAT)

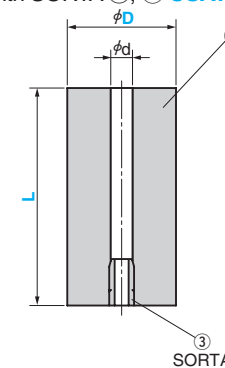

SORTA

USA

(with SORTB ①, ③ USATB)

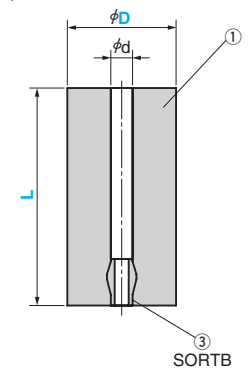

SORTB

Material: Polyester type Shore A90

*Retainers and bolts for each catalog No.

Retainer (③)

SORTA

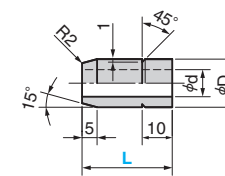

SORTB

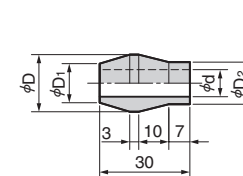

Urethane D	Catalog No.		④ Bolt Used
	USPHA	USPHB	
50	SORTA 14-30	SORTB14	M8x45
70	SORTA 22-35 (M12x55)	SORTB22 (M12x50)	Refer to () in the left
90			
100			
110			

① Urethane Spring					② Urethane Storage Pipe				Catalog No.	D	L	Safety Color	
D	L	d	S	S=Lx20% F(kN)	D ₁	L ₁	d ₁	t					
70	110	22	22	22.0	89.1	85	109	2.8	USPHA USPHB USPH (Note)	70	110	R (Red)	
	140		28			85					110		
90	110	22	22	35.0	114.3	85	157	3.2		90	140		Y (Yellow)
	140		28			109					140		
	200		40			109					200		
100	140	28	28	42.5	139.8	109	157	3.6		100	140		
	140		28			109					140		
110	140	28	28	53.9	139.8	109	157	3.6		110	140		
	200		40			109					200		

Order	Catalog No.	D	L	Safety Color
	USPHA	90	200	R
	USPH	70	110	R

Note:USPH110-140 are common standard with USPH100-140.
When ordering USPH110-140, please instruct USPH100-140.

Urethane Spring (USA : ①, USAT·USATB : ①·③)

d	Catalog No.	D	L
14		50	110
		70	110
		70	140
22	USA USAT USATB	90	110
		90	140
		90	200
		100	140
		110	140



Order	Catalog No.	D	L
	USA	70	140
	USATB	90	200

Retainer (③)

D	d	Urethane Diameter	Catalog No.	Nominal	L
16	9	50	SORTA	14	30
24	13	70~		22	35



Order	Catalog No.	Nominal	L
	SORTA	22	35
	SORTB	14	

D	D ₁	D ₂	d	Urethane Diameter	Catalog No.	Nominal
19	13	14	9	50	SORTB	14
27	20	22	13	70~		22